

1703



THE EZ PANEL SUKKAH

USA Patent

Assembly Instructions



Sukkah Depot™

1-855-SUKKAH-1 | www.sukkahdepot.com

PAGE 1

Please Note:

All panels work on a male / female assembly system.
So using two male sides or two female sides will not work.

The Light wood of the panel is always on the inside of the Sukkah.
The dark wood is always on the outside of the Sukkah.

Please stand the panel so that the black plastic caps are on the bottom (on the floor) and the white plastic caps will be on top.

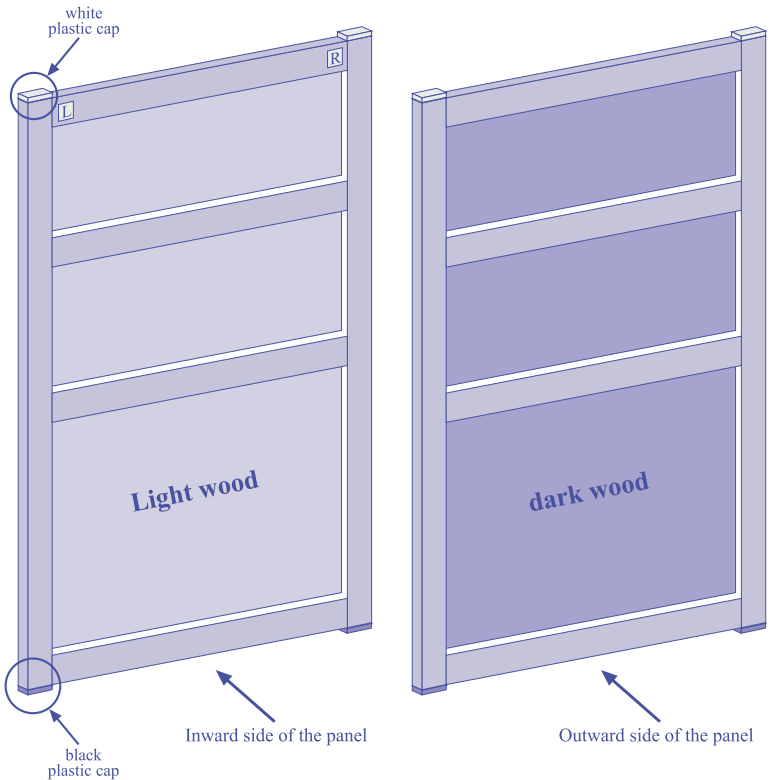

How to connect the corner:

(The following pictures show a cut from the top of the sukkah)

How to connect the corner:

Place the panel with the male connector **R** at a 45° angle against the opposite female panel **L**

Please make sure that the projection on the profile is inserted into the groove down the full length of the opposite connecting profile.

After inserting the male connector down the full length of the groove on the opposite panel, you must finish the connection by straightening the panels to a 90° angle. (picture 4)

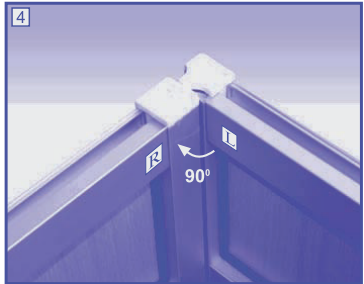

How to connect the side panels:

(The following pictures show a cut from the top of the sukkah)

How to connect the side panels:

Place the panel with the male connector **R** at a 135° angle against the opposite female panel **L**

Please make sure that the male connector on the profile is inserted into the groove down the full length of the opposite connecting profile.

After inserting the male connector down the full length of the groove on the opposite panel, you must finish the connection by straightening the panels to a 180° angle (straight wall). (picture 4)

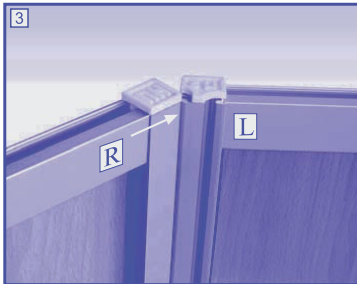
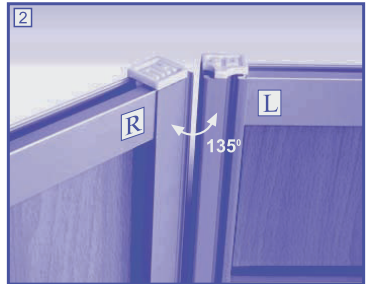
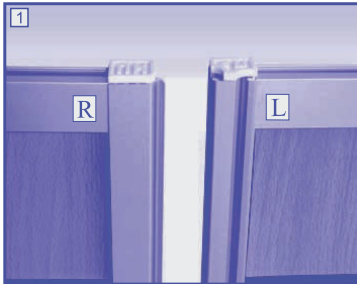
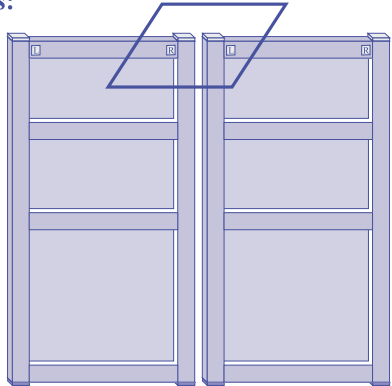

The order in which to connect the panels:

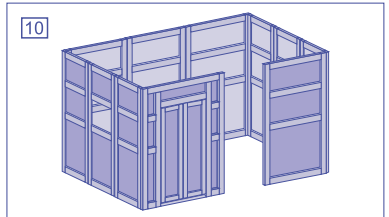
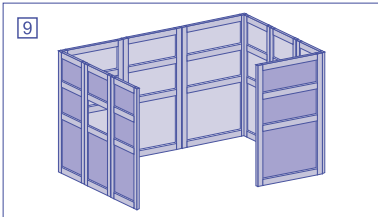
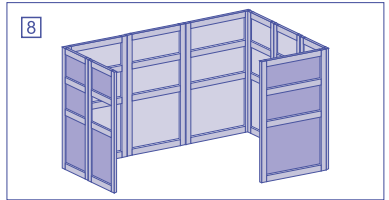
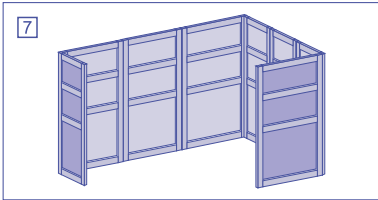
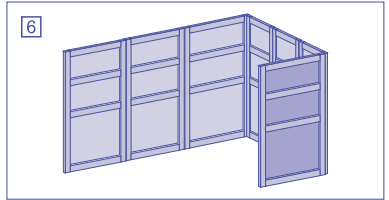
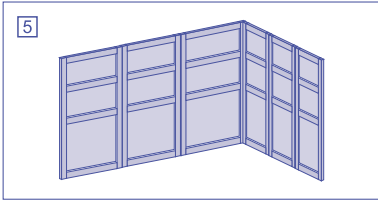
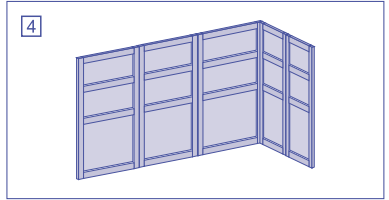
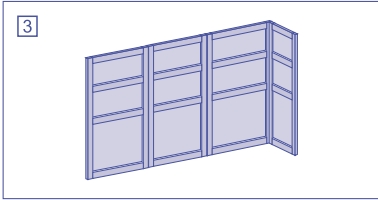
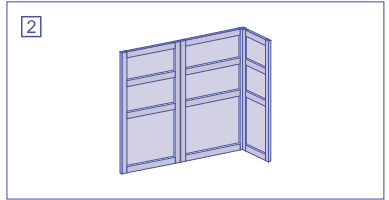
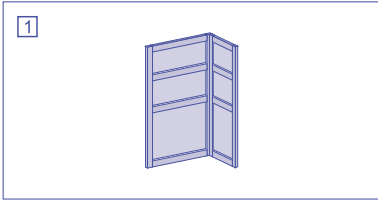

How to connect the last panel:

Step 1: Please push the last two panels outward

Step 2: Please insert the projection on the profile into the groove down the full length of the opposite connecting profile.

Step 3: Please push the panels back into position, so that the panels are straight and make sure that the connection was correctly made down the full length of the profiles.

Please note: The connection of the last two panels must never be made at the corners of the Sukkah

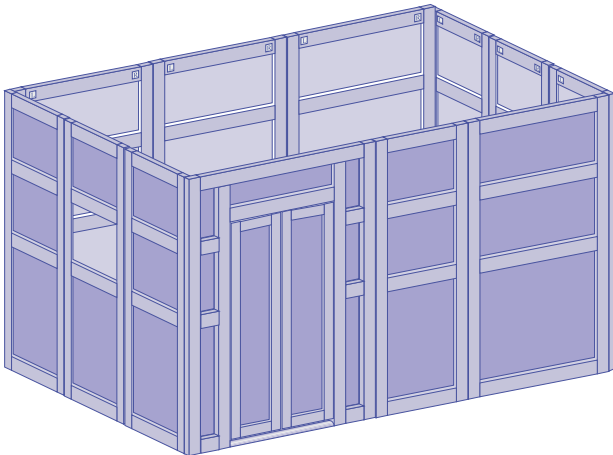
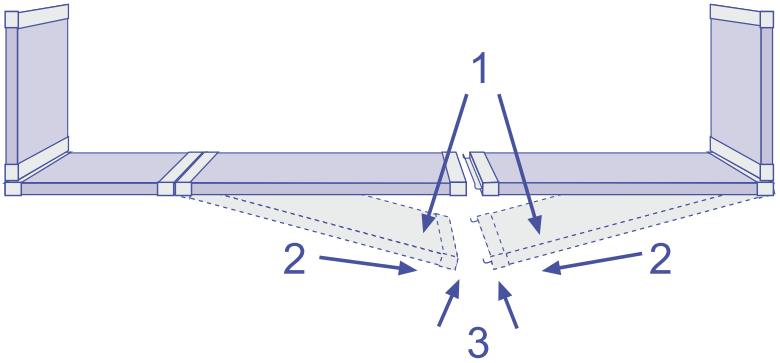

If you have purchased connectors with the Sukkah, the following are the assembly instructions for the connectors:

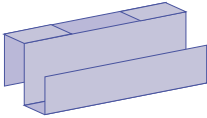

Big Connector

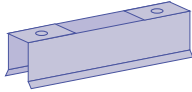

Small Connector

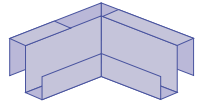

Corner Connector

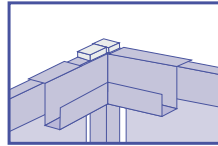
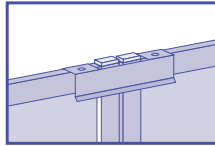
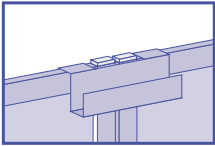
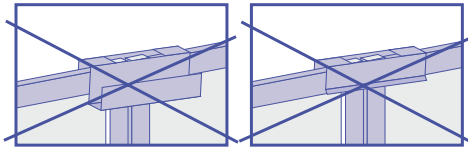

Please make sure that the connector is placed in its proper place so that the white plastic caps protrude above the connector surface (as shown in the above sketches)

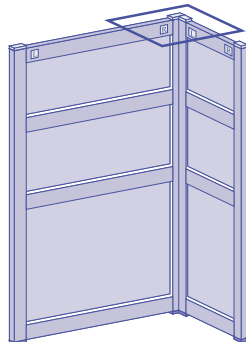
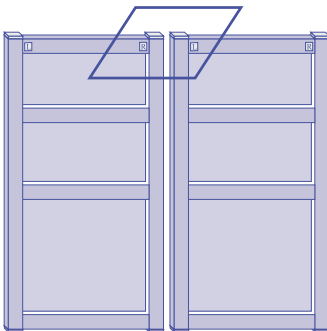

How to attach the handles:

In the center of the door there are two holes for the purpose of attaching the handles. There are two holes on the left side and two holes on the right side. The holes are closed by plastic plugs. Please take out the plugs from the holes on the side you wish to open (the side you opened the hinges) You must screw on the handles from both sides of the door.

