

Sukkah Depot™

EZ LOCK SUKKAH INSTRUCTIONS

CLASSIC / ROYAL / PREMIUM

7' TALL

7.5' TALL

8' TALL

10'X12'

PARTS LIST

- **RODS**

4 X CORNER VERTICAL RODS

2 X TRIPLE CONNECTING RODS

11 X 6' HORIZONTAL RODS

7 X 10' HORIZONTAL RODS

The rods are packed in 3 boxes

- **FABRIC**

- **8 BAMBOO HOLDERS**

- **RUBBER MALLET** *(optional)*

Sukkah Depot™

1.855.SUKKAH-1
1-855-785-5241

SUKKAHDEPOT.COM

GENERAL INSTRUCTIONS

In this instruction booklet we recommend a method for constructing the Sukkah that we think is the easiest, fastest and most convenient. However, you can use any other method that achieves the desired result.

When planning the placement of the Sukkah, please take into consideration that it is recommended to place the door on the right side of the long wall.

To avoid any damage to the metal frames, we recommend using a rubber mallet to connect the rods.

STEP 1: ASSEMBLY OF THE SUKKAH FRAME

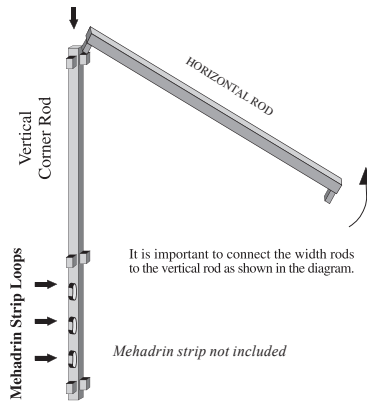

Every vertical rod is divided to two unequal parts, long and short. Make sure when assembling the sukkah that the shorter corner is at the bottom.

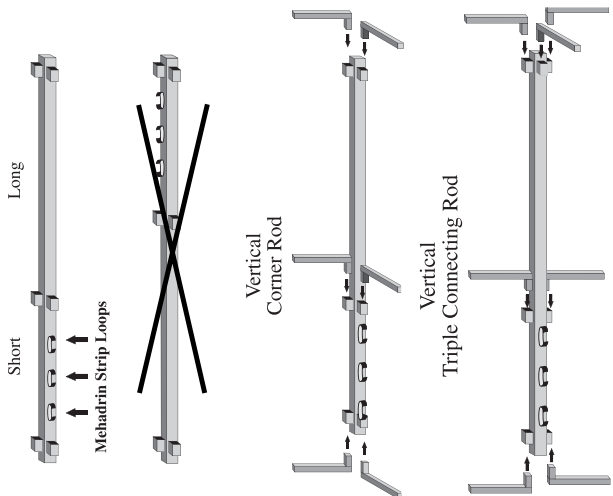

- 1** Start assembly at the corner.
2. Place the horizontal rods on the ground in the right place with the pin facing upwards (see diagram).
3. Connect the corner rod to the horizontal rod on the ground.

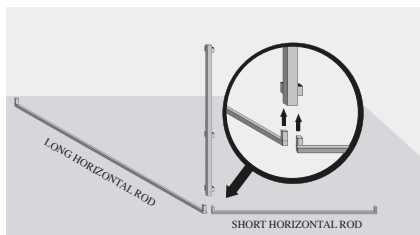

- 2** Connect the triple connecting rods between two shorter horizontal rods lying on the ground. (see diagram).

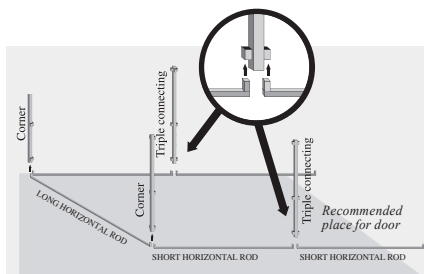

- 3** Attach the upper horizontal rods, plus the upper middle horizontal rod.

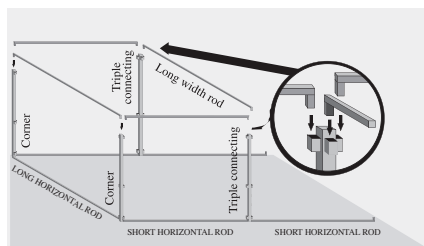

- 4** Continue to connect the upper horizontal rods.

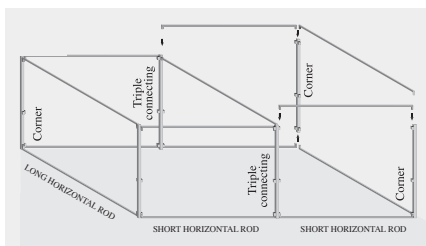

- 5** Connect the middle horizontal rods on three sides. Do not attach a horizontal rod in the middle of the longer wall where the door will be located.

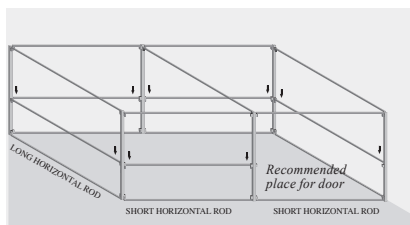

Congratulations!

You have finished constructing the frame of the Sukkah. For instructions on attaching the fabric and laying the Schach please see back page.

STEP 2. ATTACHING THE FABRIC

1. Unpack the fabric. For your convenience we recommend spreading it on a clean surface.
2. Find the door and position it as shown in diagram 1. Spread around the Sukkah. Please ensure that the bright part is on top and the dark part is on the bottom.
3. Use the strings to attach the beginning (the door) of the fabric to the right corner of the long wall. (Diagram 2)
4. Start wrapping the frame with the fabric (Diagram 3).
To attach the fabric use the upper Velcro fasteners first.
5. Finish wrapping the fabric around the Sukkah. Fasten the over lap (Diagram 4).
6. Fasten the lower Velcro fasteners, including those at the bottom of the door.
7. Fasten the middle Velcro fasteners.

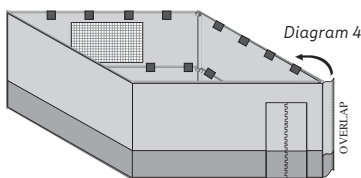
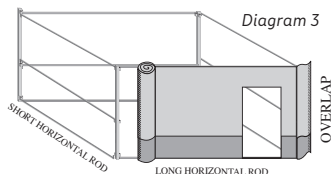
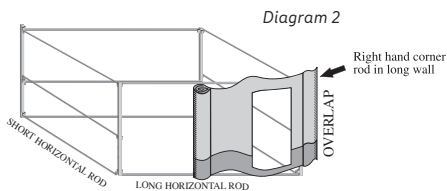
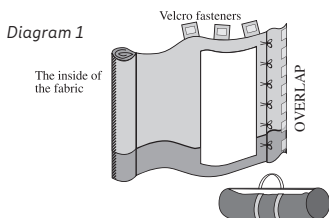

STEP 3. LAYING THE SCHACH

1. Please make sure to finish constructing the Sukkah before laying the Schach. (Obligatory according to Halacha)
2. Lay the bamboo sticks to support the Schach.
In order to stabilize the bamboo sticks use the bamboo holders. (Diagram 5)

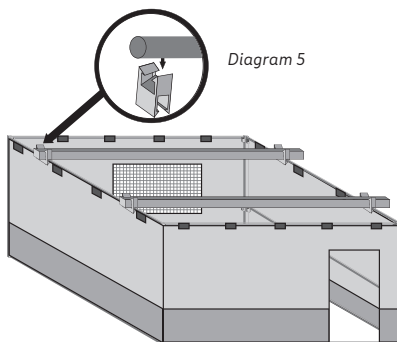

3. Spread the Schach by unrolling it on the bamboo sticks. (Diagram 6)

Sukkah Depot is not responsible to supply bamboo sticks to support the schach if not ordered.

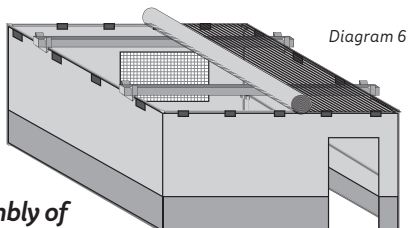

Congratulations! You have completed assembly of the Sukkah. We wish you a Chag Sukkot Sameach!